

# What is new in CGS Labs Civil Solutions 2020.1

---

Software Build version: 200 and higher

Document date: 17 January 2020



CGS Labs d.o.o., Brnčičeva ulica 13, 1000 Ljubljana, Slovenia

## Content

1.	BricsCAD v20 platform support .....	3
2.	CGS Labs Civil Solution Release notes.....	3
3.	CGS Labs Civil Solutions 2020 enhancements.....	4
3.1.	BIM functionality.....	4
	Property Set Filter .....	5
	Clash detection .....	5
3.2.	Geospatial data: .....	7
	Export (3D solid objects) to Google Earth.....	7
	Coordinate systems support.....	8
3.3.	Plateia, Ferrovia & Aquaterra design enhancements .....	9
	NEW: Project Intersection Lines to Profile with no Sample lines present.....	9
	Intersection Lines improvements / Projection Lines UI enhancements.....	9
	Upgraded Sample lines & Upgraded Correspondent sample lines.....	10
	Insert Profile View & Cross Section Views table(s).....	10
	Cross-Sections zoom .....	11
	Material polygon display ON/OFF.....	12
	MACRO (Cross sections geometry library).....	12
3.4.	Other general information.....	13
	New CGS Labs 2020 installations .....	13
	New license manager.....	13
	CGS Labs 2020 backward compatibility .....	13
	User interface improvements .....	14
4.	Autosign Professional .....	14
	Traffic sign and road markings libraries.....	16
	Autosign for Plateia users .....	16
	Autosign for Civil 3D users .....	17
	Autosign for AutoCAD & BricsCAD users .....	17
5.	Autopath Professional .....	18

## 1. BricsCAD v20 platform support

New CGS Labs Civil Solutions 2020.1 installation with build number 200 or higher brings the support for **BricsCAD V20** platform. We suggest to install it on BricsCAD version v20.1.07 or higher.



CGS Labs 2020.1 Civil Solutions, current CAD platform support:

<b>BricsCAD</b>	<b>V20, V19, V18</b>
<b>Autodesk AutoCAD / Civil 3D</b>	<b>2020, 2019, 2018, 2017, 2016, 2015, 2014, 2013</b>

Slight alterations in functionality or unsupported functionality could result due to CAD platform differences, API changes between versions or unavailable compared functionality between AutoCAD and BricsCAD platforms. Make sure you have always updated CAD platforms to their latest release versions.

Alongside new platform support, the new installation delivers number of enhancements, issues fixed and new functionality described in document below.

## 2. CGS Labs Civil Solution Release notes

Effective communication channel is a key to deliver up to date information on new releases content. We have set up a dedicated Web page with current “What’s new” documentation and “Issues solved” information.

Visit [https://cgs-labs.com/Release\\_notes/](https://cgs-labs.com/Release_notes/)



## 3. CGS Labs Civil Solutions 2020 enhancements

### 3.1. BIM functionality

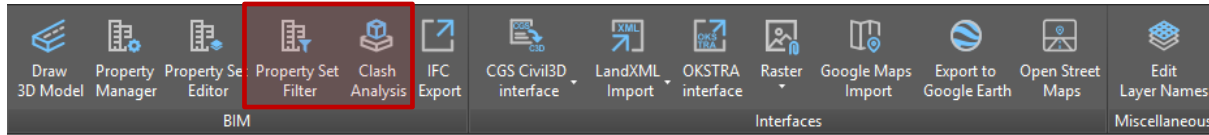

Two new features added to enhance 3D BIM models design:

- Property Set Filter
- Clash Detection

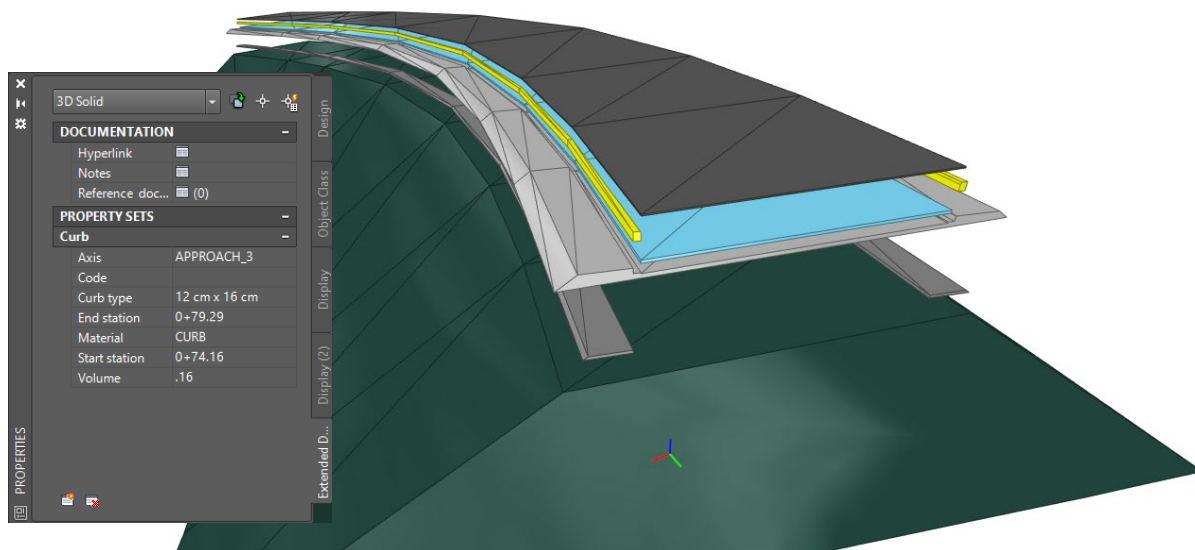

## Property Set Filter

Select, isolate or hide objects containing selected material definition within the 3D solid (BIM) models by simply selecting desired material name. Property Set Filter option works as a great tool to query, export or manage desired 3D solid objects within large 3D models containing great number of entities.

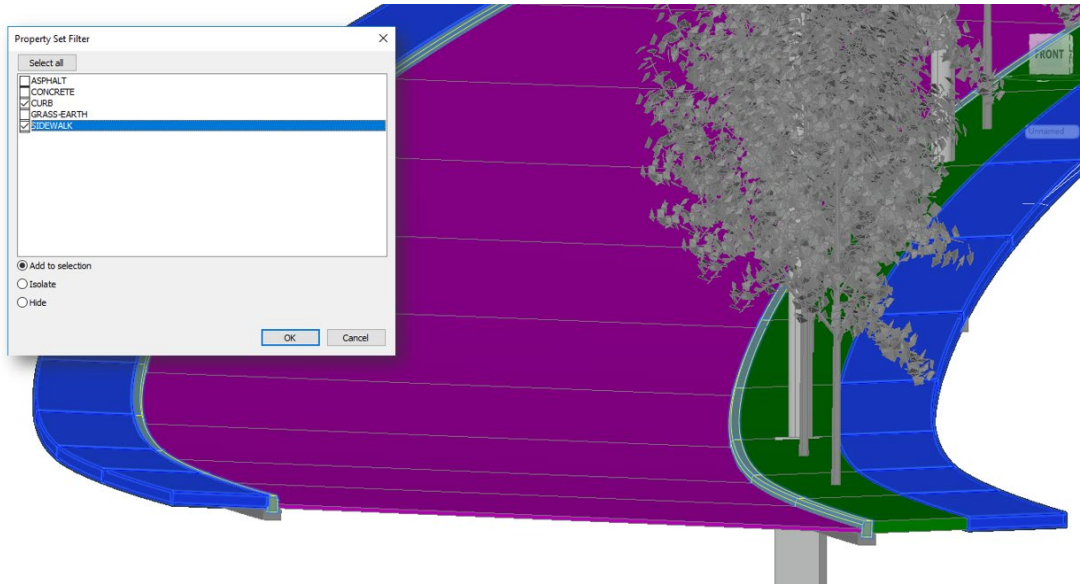

*Property Set Filter: Select all 3D solid objects containing “CURB” and “SIDEWALK” material definition*

## Clash detection

Clash detection tool enables designers to search for possible clashes among selected 3D solid objects within the drawing itself thus saving the time to export models and create clash analysis in third party applications outside CAD environment.

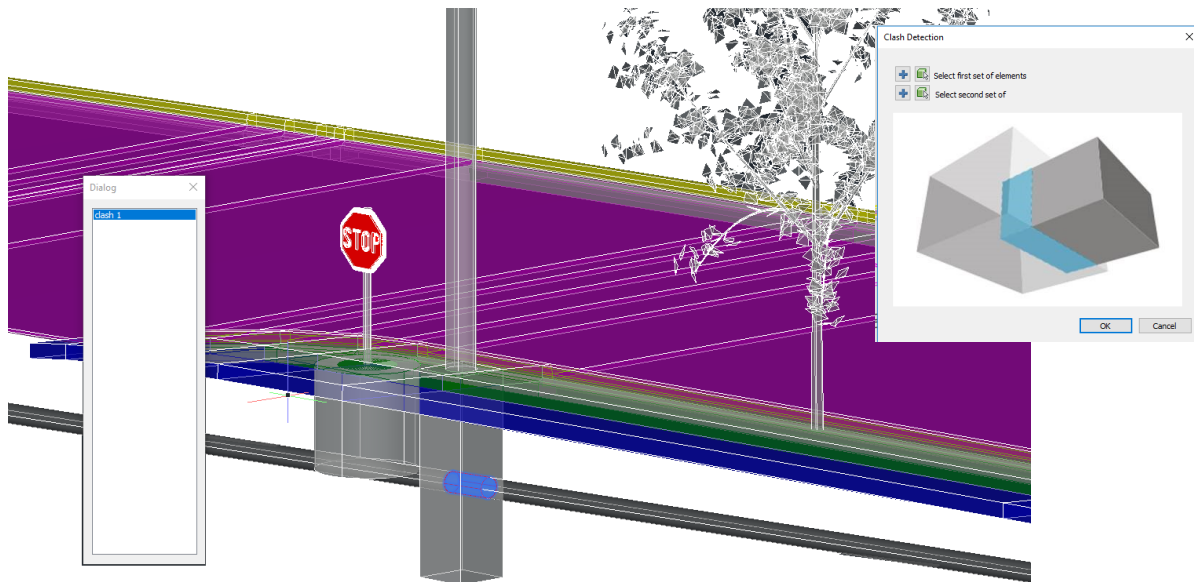

*Clash Detection: Detecting 3D solid collision between the pipe and the street light foundation*

CGS Labs Civil Solutions already provide number of other BIM features including:

<b>3D BIM model creator</b>	With Property Sets attached to 3D solid objects.
<b>Property Manager</b>	Enabling users to design custom Property Sets names, properties and attribute values.
<b>Property Editor</b>	Giving users the option to edit Property Set definitions for single or selection of 3D solid objects.
<b>Export to IFC</b>	Exporting all or selection of 3D solid objects with Property Set definitions to external IFC exchange file
<b>CGS Labs – Civil3D interface</b>	Convert any CGS Labs alignment & profile to Civil3D alignment & profile and vice versa. A great and comfortable tool on “a click of a button”.
<b>LandXML Import/Export</b>	Interface enabling alignments import from LandXML data files and export capabilities to save CGS Labs alignments for data exchange with other SW solutions.
<b>Okstra Export</b>	Predominantly German market oriented exchange format that happens to be a source for latest international IFC data exchange format definition.

## 3.2. Geospatial data:

Google Maps Import capability, which enables users to import geospatial data:

- Maps imagery,
- Elevation data, and
- Street View

Google Maps data imports directly into the CAD drawing. The 2020 CGS Labs release brings new geospatial features:

### Export (3D solid objects) to Google Earth

Newly enhanced Export to Google Earth feature enables users to export

- selected 3D solid and other elements like
- lines,
- polylines

From the CAD drawing to Google Earth on “a click”. Thus offering a convenient way to represent designed project in a geospatial environment offering great visualisation impact. Saving data to a KML file is also an option to share the model data conveniently.

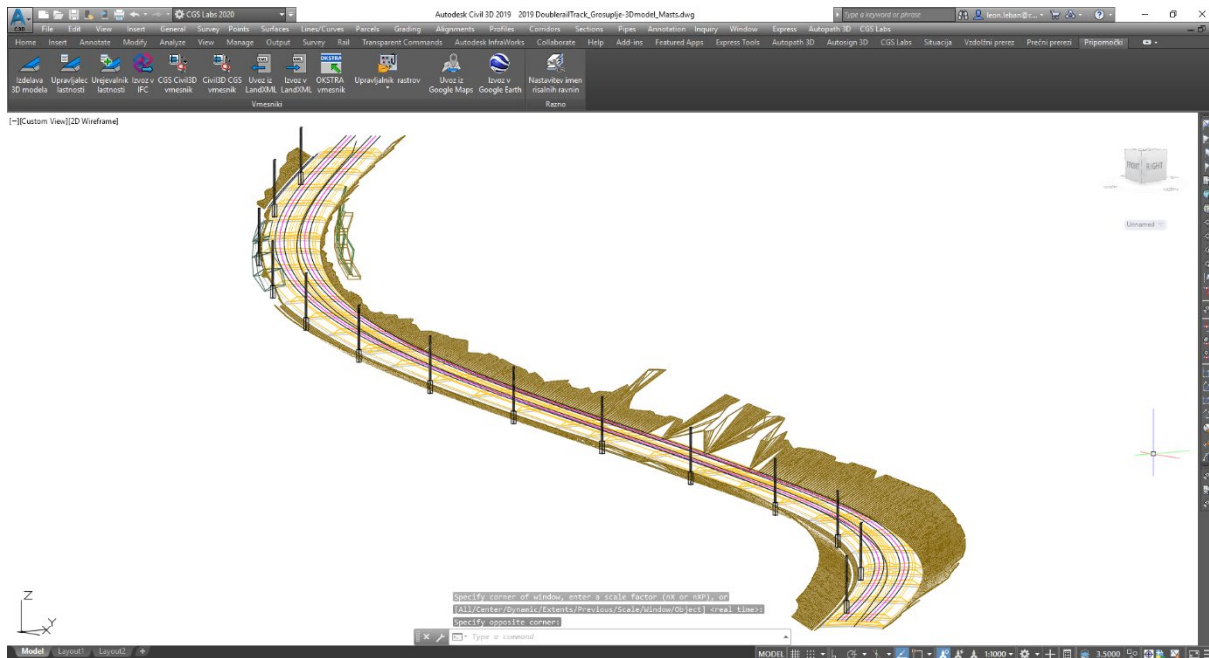

*Export 3D solid object from CAD drawing to Google Earth*





*Export tool positions exported 3D solid and other objects to exact location in areas with supported coordinate systems.*

**NOTE:** 3D objects export to Google Earth is only supported in Autocad platforms.

### Coordinate systems support

Alongside a large list of existing coordinate systems, we have added new ones for the following areas: Jordanian, Israel, Pakistan, Saudi Arabia, Cameroon, Iran, Romania, Georgia, and Ethiopia ...

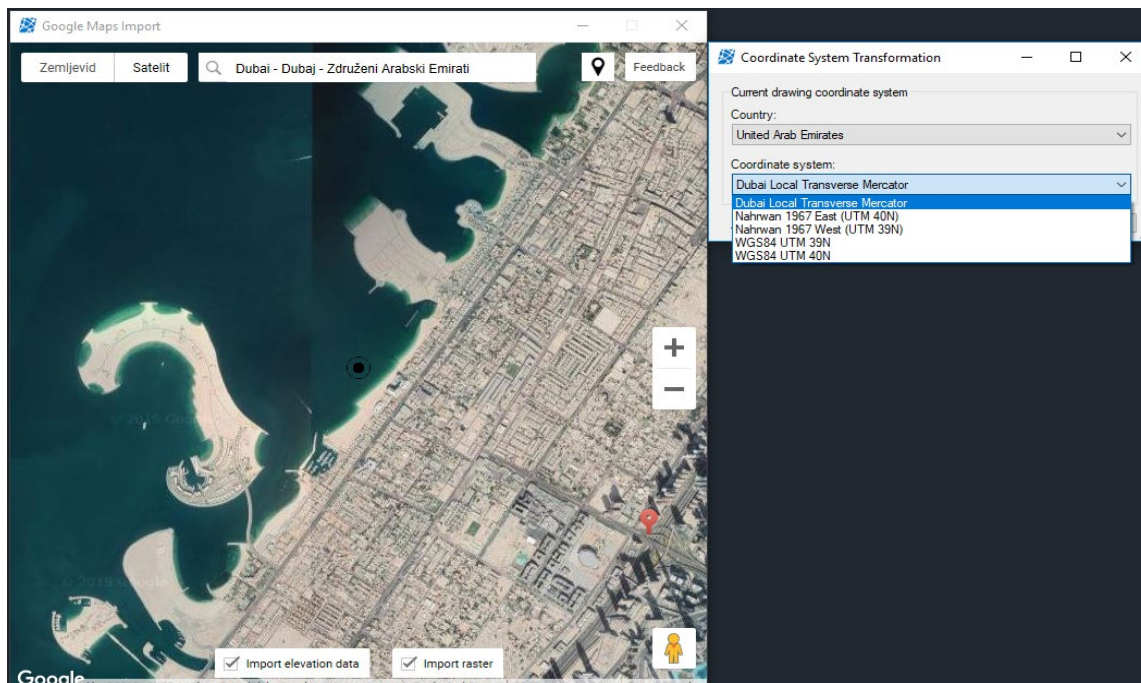



### 3.3. Plateia, Ferrovia & Aquaterra design enhancements

#### **NEW:** Project Intersection Lines to Profile with no Sample lines present

Up to current version, Sample Lines defined on Alignment were mandatory in order to be able to project Intersection lines to Profile View. This is no longer needed as projection works with or without Sample Lines defined. Thus making the design process faster and more 3D oriented than ever before.

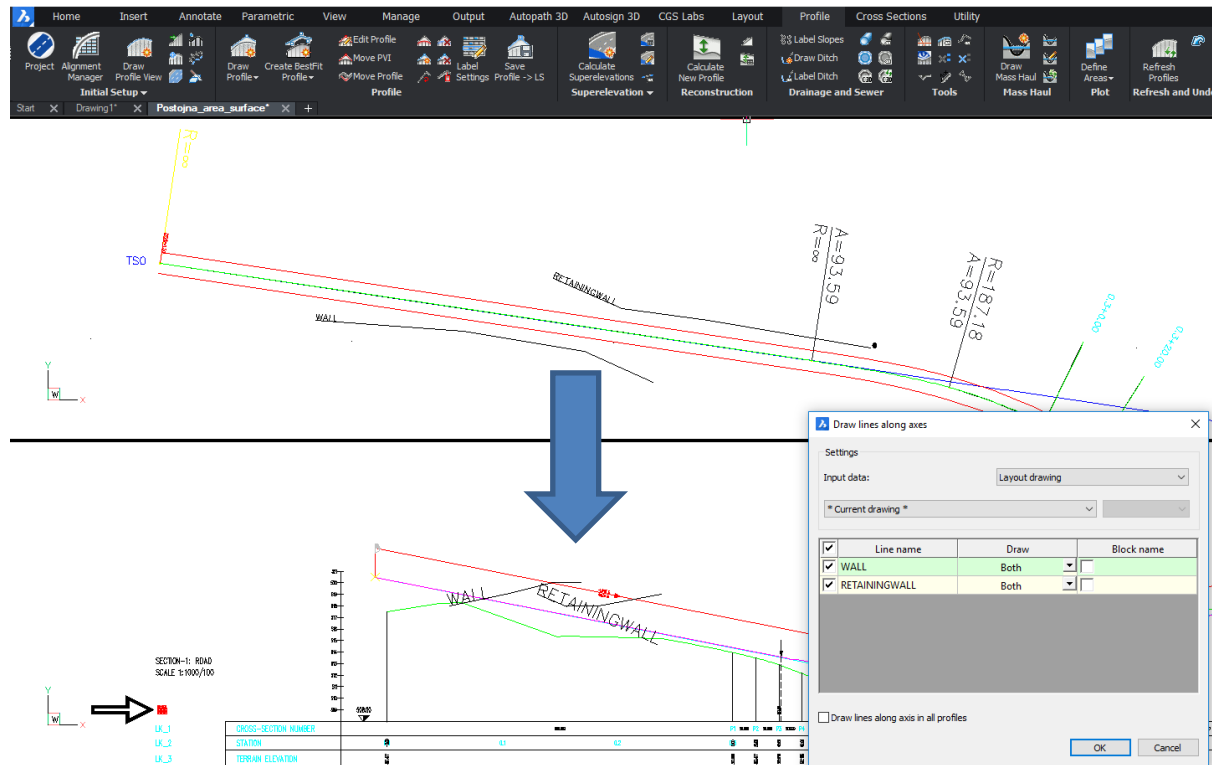

#### **Intersection Lines improvements / Projection Lines UI enhancements**

Intersection lines User Interface is now unified throughout Layout/Profile views/Cross Section Views offering better user experience with enhanced options to:

- select/deselect all intersection lines,
- arrange list of intersection lines by a-z/z-a, or
- selecting user desired intersection lines in the list.

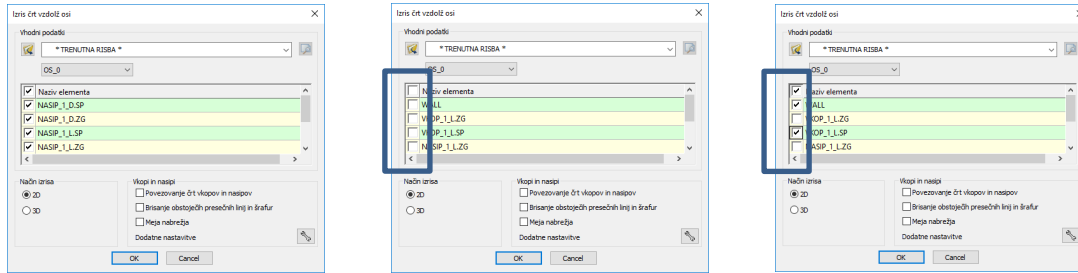

### Upgraded Sample lines & Upgraded Correspondent sample lines

In projects where single drawing contained multiple alignments designed and had sample lines on multiple alignments with the same prefix defined (cross section view tables names) problems occurred with data compatibility when they sample lines were changed to correspondent sample lines. Thus resulting there were two P1, P2, P3 ... sample line names on the same alignment.

In CGS Labs 2020 version changing correspondent samle lines results in assigning an \* to correspondent sample line which is a visible label for a user. In the background all sample lines now get a relative alignment name assigned for the software to know to which alignment they belong to.

### Insert Profile View & Cross Section Views table(s)

Draw Profile View enhancement provided where displaying correspondent Sample Lines (marked with \*) is an option

Cross Section View funtionality added where users have the option to draw Cross Section Views which include correspondent sample lines (marked with \*), or Cross Section Views without them.

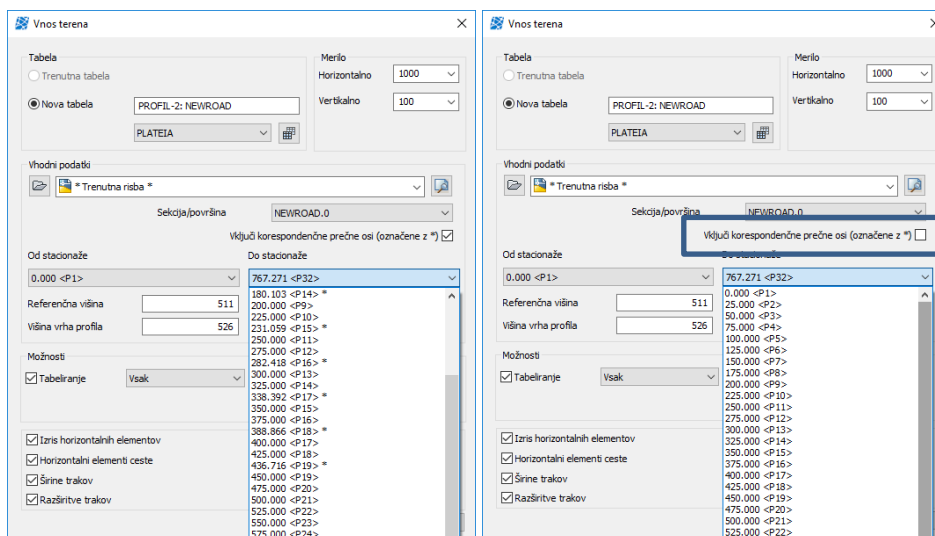

### Cross-Sections zoom

The interface for zooming to specific Cross-Section (CS) View or elements within the CS Views replaces existing Zoom commands.

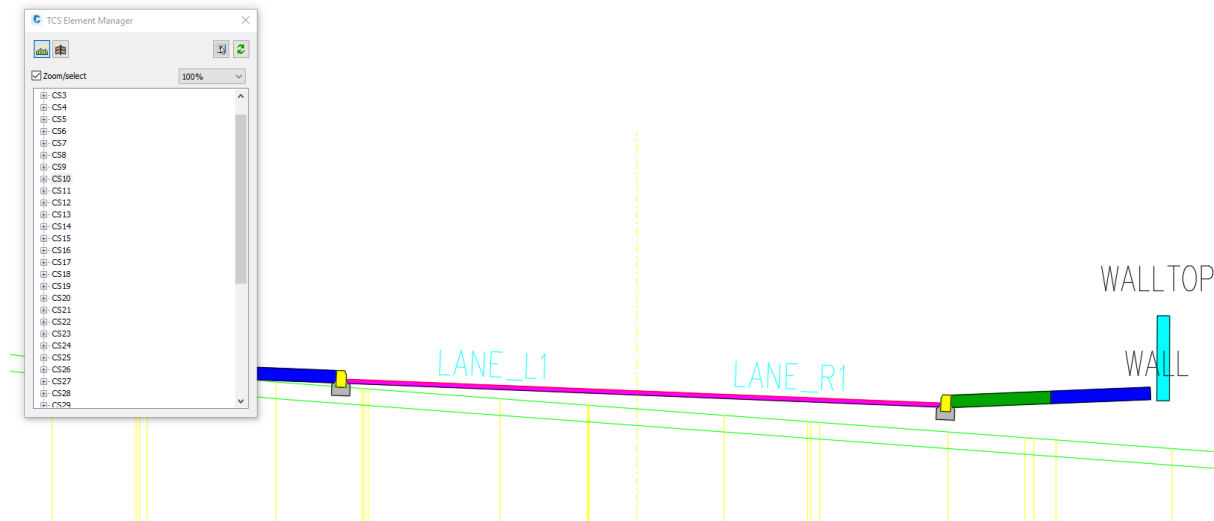

*Zoom to selected Cross-Section View number*

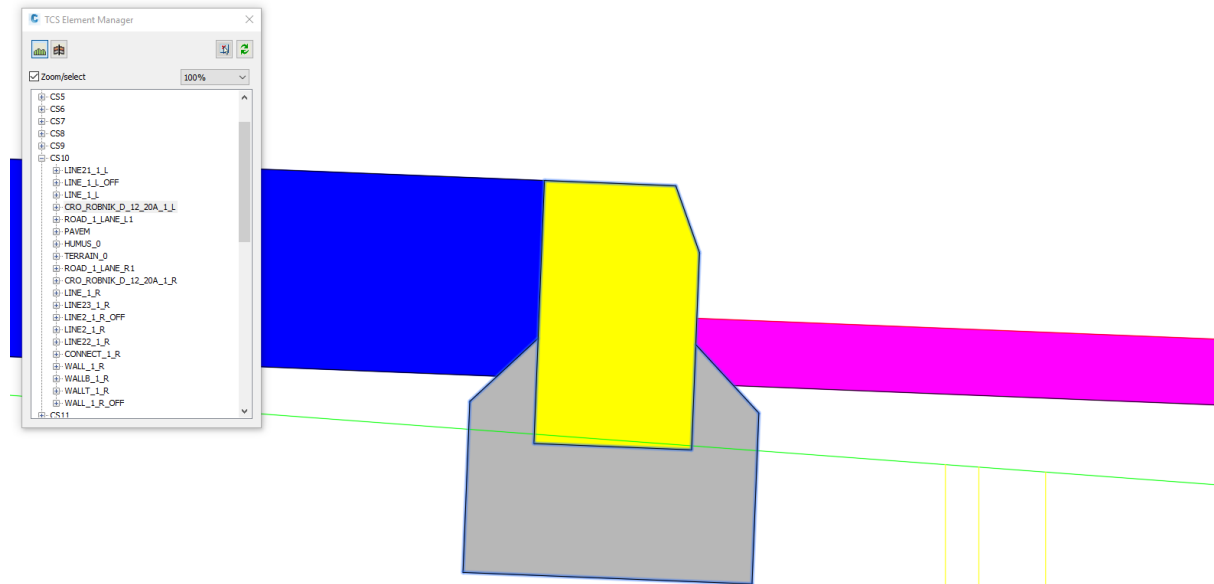

*Zoom to specific Cross-Section element*

### Material polygon display ON/OFF

New interface for managing the material polygon visibility (QTO defined materials in Cross-Section Views) allows users to toggle visibility ON/OFF by simply pressing the bulb icon next to material listed.

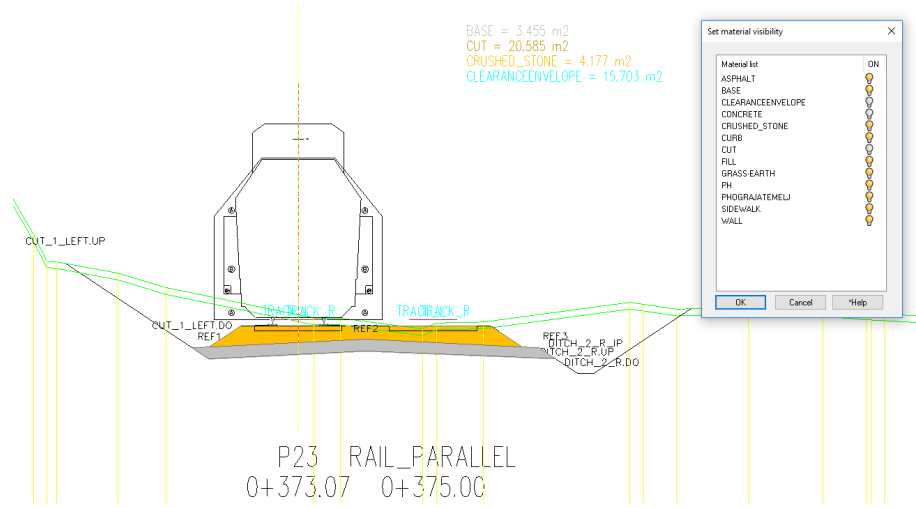

### MACRO (Cross sections geometry library)

Marco command gets new exposure in Cross Sections and gets additional “Copy element” feature added to round up the Macro capabilities.

Create detailed typical cross section geometries with material definition and labelling and store this definition for later/next time use into Macro library by simply clicking the “Save Macro” command and selecting the cross section view with desired geometry. A list of Macro definitions can be made for fast re-creation of complex cross section geometry next time around.

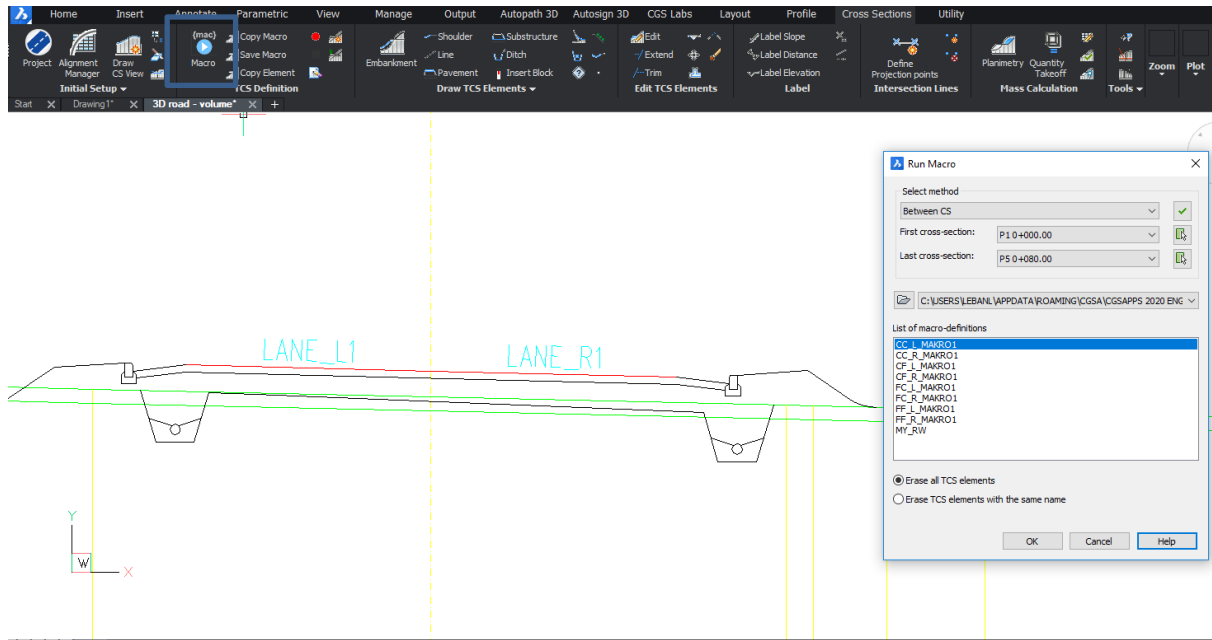

### 3.4. Other general information

#### **New CGS Labs 2020 installations**

All CGS Labs Civil Solutions, which include Plateia, Ferrovia, Aquaterra, Autosign, Autopath and Electra, are part of a new major software version release resulting in side-by-side installations with previous CGS Labs versions.

No automatic upgrade to 2020 version from 2017.X versions is available.

All CGS Labs Civil Solutions come in a single installation file while language selection is available during the installation process and first run of the program. Note, language selection predefines country standards use, e.g. German language sets German version with its standards.

#### **New license manager**

CGS Labs 2020 installation comes with a new License Manager. Therefore, users need to obtain new license and activate it in order to work with the new 2020 version.



CGS Labs opted for an OEM License Manager Solution provided by Reprise Software, which should result in better user experience managing different licenses, single or network. Reprise Software is an established LM developer offering its licensing solutions to established companies worldwide.

#### **CGS Labs 2020 backward compatibility**

CGS Labs 2020 solutions are fully compatible with CGS Labs older versions resulting in uninterrupted work with older DWG files or projects made years ago. Thus, saving time and interfaces needed to port projects to latest version. CGS Labs versions from 2013 to 2020 should all provide high level of compatibility.

In addition, road, railway, river canal and other projects made with latest CGS Labs 2020 version on ACAD 2020 or BCAD v19 platforms can fully worked on with CGS Labs 2020 version on any older ACAD platform down to 2013 version or BCAD versions v18.

## User interface improvements

Autopath, Autosign and BIM module got a new ribbon look in 2020 version, which is going span over all CGS Labs Civil Solutions. Both solutions also got new product packages, Professional and Ultimate.

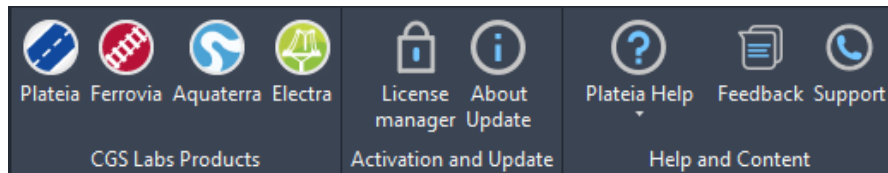

Aquaterra 2020 now sports full BIM capabilities as the rest of CGS Labs solutions. Projection points and line projection form part of Layout/Profile Views and Cross-Section Views sets of commands with additional 3D solid projection option added and full Cross-Section Macros design & editing capabilities. Geospatial and BIM features form part of Aquaterra utility Tab.

Electra ribbon now includes functions covering Geospatial data import and export capabilities.

## 4. Autosign Professional

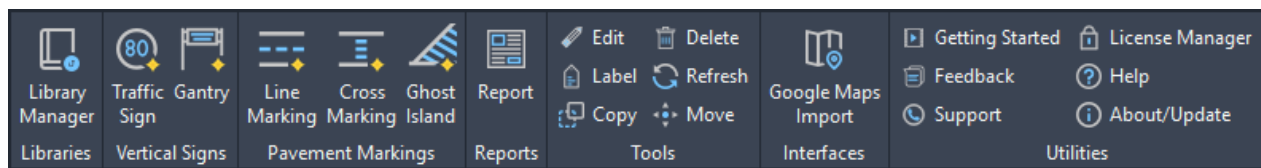



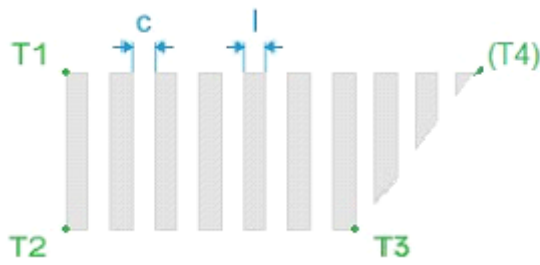
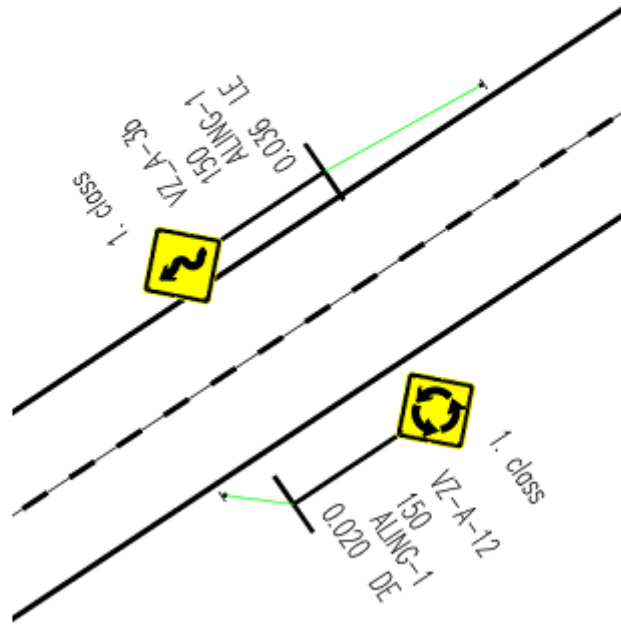
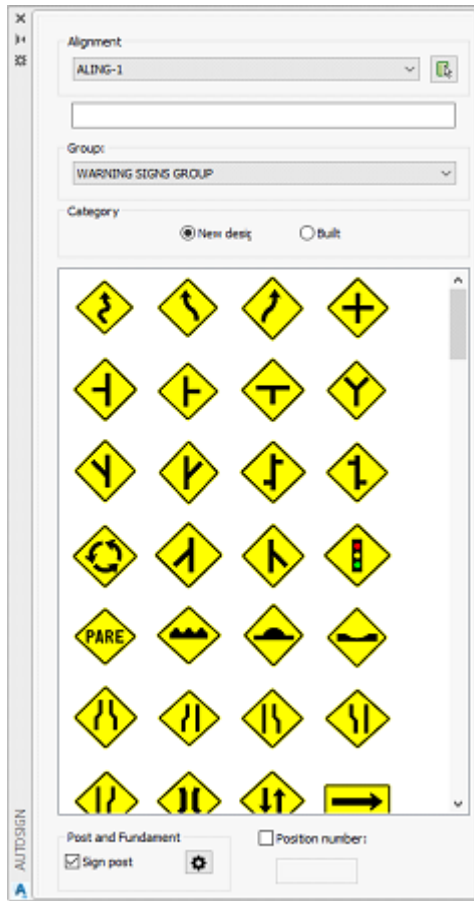

Bringing enhanced road signs and markings design tools

- Road gantry design
- Traffic lights
- Safety Barrier design
- Other road furniture objects designs
- Colouring option (coloured bike paths for example)
- Number of country specific road signs & marking libraries available
- Custom libraries creation options





Reports make an important part of Autosign Professional package offering clients to create report tables in the drawing or export them to Excel sheets directly:

				Abmessung	Anzahl der Platten	Anzahl der Zeichen	Code	Höhe	Höhe der Platten	Kommentar	Position	Schemata	Status
					1		0.000	150	220	1			
					1		0.000	150	220	1			
								150	220	1			
								150	220	1			2207-1

Abmessungen	Abmessungen			Farbe	Kommentar	Leistestyp	Weg	Position
	A	B	C					
			0.15	WHITE	51.96 m2	Doppelstrich zweiseitig, B=0.15	173.19 m	
	6.00	3.00	0.15	WHITE	71.83 m2	Doppelstrich unterbrochen, B=0.15, L=6.00, A=3.00	355.87 m	
			0.15	WHITE	23.91 m2	Fahrbahnbegrenzung, B=0.15	158.40 m	

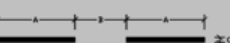
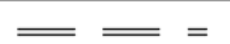
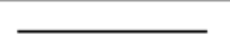
### Traffic sign and road markings libraries

Autosign includes up to date country specific libraries of traffic signs and road markings available to download within the Autosign functionality:

*AASHTO, Austrian, German, Croatian, Slovenian, Serbian, Norwegian, Swedish*

Alongside complete libraries, there are DEMO country libraries of signs and markings available:

French, Lithuanian, Brazilian, Romanian, with more libraries added regularly

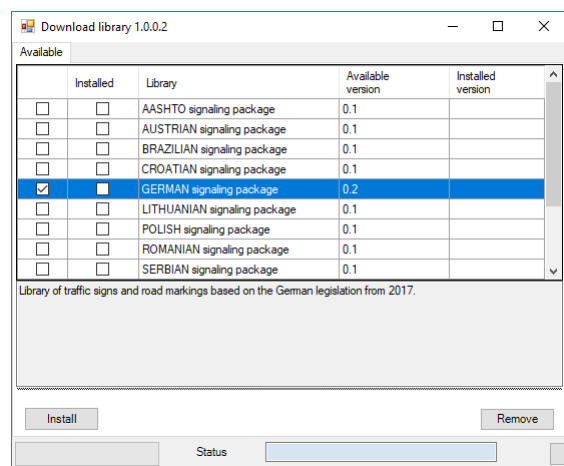

### Autosign for Plateia users

Autosign forms part of Plateia Professional and Ultimate packages and brings traffic design and management functionality:

- Traffic signs
- Road markings
- Gantries
- Colouring options
- Cones, bollards and safety barriers
- Reports
- 3D representation & visualization of elements

Objects placement supports linkage to Plateia alignments with automatic stationing assigned, user comment added, custom labels and more. Autosign functionality depends on Plateia package. Plateia Professional includes Autosign Professional and Plateia Ultimate includes Autosign Ultimate functionality.

### Autosign for Civil 3D users

Autosign is fully compatible with AutoCAD Civil 3D. Supporting the Civil 3D surface, alignments and feature lines the placement of signs and road markings as well as other traffic design objects is seamless.

Stationing information is automatically assigned to signs, gantries etc. in relation to alignment they belong. Representing signs, markings in 3D mode by projecting to any selected Civil 3D surface is also supported.

Furthermore 3D Autosign objects data exchange between Civil 3D, Navisworks and InfraWorks solutions is fully supported.

### Autosign for AutoCAD & BricsCAD users

Using Autosign on top of Civil 3D, plain AutoCAD or BricsCAD should bring user the same or similar functionality and capability to design traffic signs, road markings and other traffic objects. The differences depend on objects these CAD platforms support.

Supported objects on various CAD platforms:

	Civil 3D	AutoCAD	BricsCAD
Civil 3D Alignment	+	0	-
Civil 3D Surface	+	0	-
Plateia Alignments	+	+	+
Plateia Surface	+	+	+
Lines and arcs	+	+	+
Polylines	+	+	+
3D polylines	+	+	+

+ Fully supported

0 Limited functionality

- Not supported

## 5. Autopath Professional

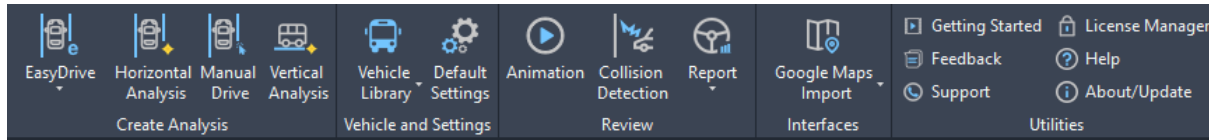

Autopath PRO is now Autopath Professional in order to be in line with other CGS Labs Civil Solution 2020 package naming convention.

The Autopath Professional 2020 version works on top of AutoCAD and AutoCAD Civil 3D 2020 versions as well as on BricsCAD V20 version.

Autopath is part of Plateia Ultimate package but can be also uses independently with a dedicated license. It comes in a single installation file but users have the option to install Autopath component only with no need to install the whole collection of CGS Labs Civil Solutions.

The Autopath Professional 2020 brings new vehicle libraries, which are updated regularly.

### **New vehicle libraries available:**

- UK FTA 1998 Design vehicles
- UK FTA 2016 Design vehicles
- Golf course vehicles
- New Boeing and Airbus aircrafts
- SUV and PICK-UP vehicles (although these were part of latest 2017.X updates already)
- With more coming soon